



EPSILON

**CRIOCABIN**  
TASTE PRESERVATION

► **COME CREARE UN AMBIENTE "COOL"**  
Strumento ideale per soddisfare i nuovi concetti di vendita che si stanno affacciando nella ristorazione internazionale.

► **HOW TO CREATE A "COOL" AMBIENT**  
The ideal tool for the satisfaction of the new sales concepts breaking through the international food and beverage sector.

► **COMMENT CREER UNE AMBIANCE "COOL"**  
C'est l'outil idéal pour satisfaire les nouveaux concepts de vente qui se présentent dans le domaine international de la restauration.

► **WIE MAN EINE "COOLE" UMGEBUNG SCHAFFT**  
Das ideale Werkzeug zur Befriedigung der neuen Verkaufskonzepte, die in die internationale Gastgewerbestätte vorkommen.











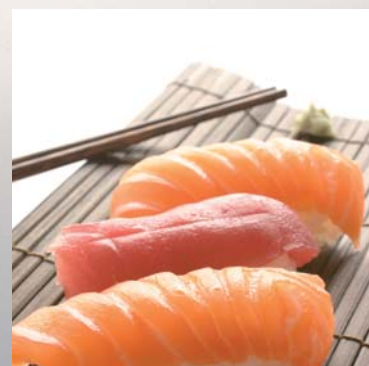







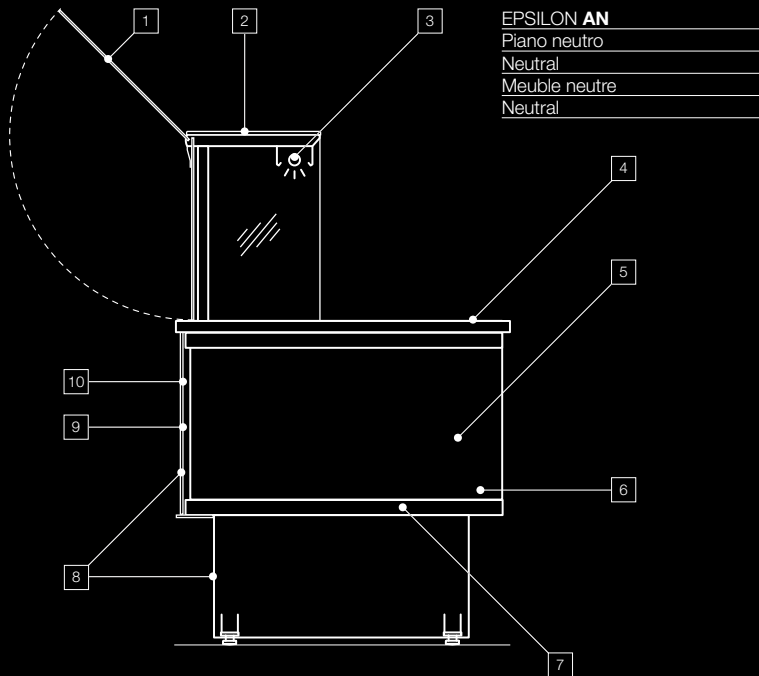

**EPSILON AN**  
 Piano neutro  
 Neutral  
 Meuble neutre  
 Neutral

#### CARATTERISTICHE DEL MOBILE

1. Vetri frontali apribili a pistoni.
2. Piano d'appoggio superiore fisso in vetro da 36 cm.
3. Illuminazione: tubo fluorescente con luce rosata Osram 76 (AN-AGN-ARV-AHC). (p)
4. Piano in agglomerato di quarzo (SILESTONE mod. Haiku). (p)
5. Riserva refrigerata a sportelli (ARV-APS).
6. Vani a giorno lato operatore (AHS-AHC-AHM-ANC).
7. Canalizzabile.
8. Frontale personalizzabile.
9. Angoli a spigolo; su richiesta eseguibili con qualsiasi gradazione.
10. Angoli arrotondati 22,5°.

#### CARACTERISTIQUES DE LA VITRINE

1. Vitres frontales, ouverture à pistons.
2. Plan d'appui supérieur fixe en verre de 36 cm.
3. Eclairage: tube fluorescent avec lumière rose Osram 76 (AN-AGN-ARV-AHC). (p)
4. Surface en quartz (SILESTONE mod. Haiku). (p)
5. Réserve réfrigérée à portillons (ARV-APS).
6. Réserve ouverte (AHS-AHC-AHM-ANC).
7. Canalisable.
8. Panneau frontale personnalisable.
9. Coins anguleux; sur demande tout degré d'inclinaison possible.
10. Angles sphériques 22,5°.

#### CABINET FEATURE

1. Front glasses, pistons opening.
2. Fixed 36 cm glass top surface.
3. Lighting: fluorescent tube with rose light Osram 76 (AN-AGN-ARV-AHC). (p)
4. Surface in quartz (SILESTONE mod. Haiku). (p)
5. Refrigerated understorage with small doors (ARV-APS).
6. Open understorage (AHS-AHC-AHM-ANC).
7. Multiplexable.
8. Customisable front part.
9. Angular corners; on demand any corner degree is possible.
10. Spherical corners 22,5°.

#### EIGENSCHAFTEN DES MÖBELS

1. Frontglasscheiben mit Stossdämpfersöffnunnr.
2. Fix montierte, obere Ablage aus Glas, Breite: 36 cm.
3. Beleuchtung: Leuchtrohr mit rosa Lichtern Osram 76. (p)
4. Oberfläche aus Quarz (SILESTONE mod. Haiku). (p)
5. Lukenunterbaukühlung (ARV-APS).
6. Offener Abstellraum (AHS-AHC-AHM-ANC).
7. Zusammenbaubar.
8. Gestaltbare Frontblende.
9. Eckige Winkeln; auf Wunsch mit jedem Winkelgrad erhältlich.
10. Abgerundete Winkel 22,5°.

(p) Personalizzabile a richiesta / Customizable on request / Personnalisable sur demande / Auf Kundenwünsche anpassbar

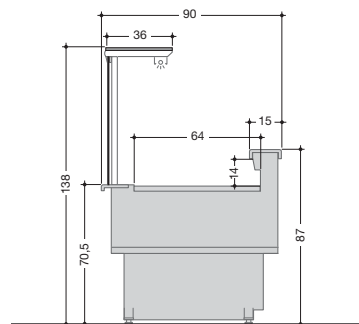

#### EPSILON AGN

Refrigerato per gastronomia.  
 Refrigerated for deli products.  
 Réfrigéré pour gastronomie.  
 Gekühlt für Feinkosten.

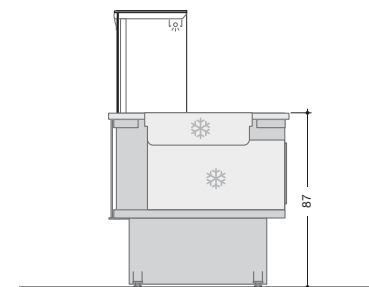

#### EPSILON ARV

Refrigerato Salad Bar.  
 Refrigerated, Salad Bar.  
 Réfrigéré, Salad Bar.  
 Gekühlt, Salad Bar.

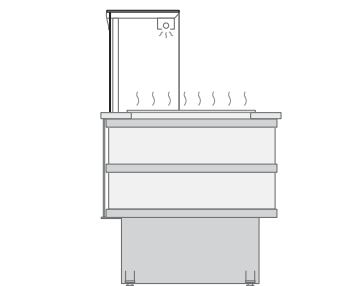

#### EPSILON AHS / AHC

Caldo piano riscaldato / Piano cottura in vetroceramica a induzione.  
 Hot, heated plate / Induction cooker in glass-ceramic.  
 Chaud, surface réchauffée / Cuisinière à induction en vitrocéramique.  
 Heiss, beheizte Oberfläche / Induktionskochfeld aus Glaskeramik.

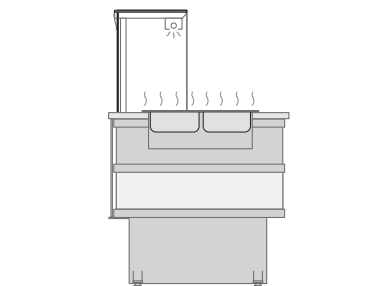

#### EPSILON AHM

Caldo bagno maria.  
 Hot bain-marie.  
 Chaud bain marie.  
 Warm bain-marie.

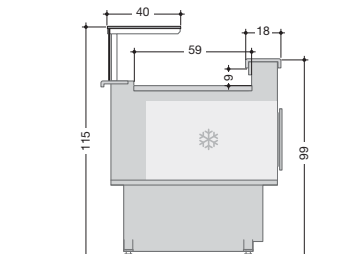

#### EPSILON APS

Refrigerato per pasticceria.  
 Refrigerated for patisserie.  
 Réfrigéré pour pâtisserie.  
 Gekühlt für Konditorei.

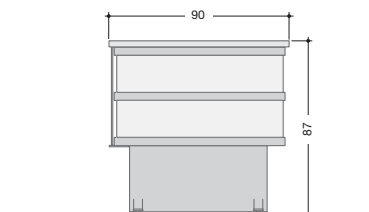

#### EPSILON ANC

Service Point.

07-10/1500 - pellino.it

Le caratteristiche tecniche potranno subire modifiche senza preavviso - Technical details could be changed without notice  
Les caractéristiques techniques pourraient subir des modifications sans préavis - Änderungen vorbehalten

**CRIOCABIN SpA** | 35033 Praglia di Teolo - Padova (Italy)  
Z.I. Selve - Via S. Benedetto, 40/A

Tel. +39 049 9909100  
Fax +39 049 9909200

www.criocabin.com  
sales@criocabin.com

